

974 ACCESSORIES FOR ENTRANCE PANELS

ALOI FLUSH-MOUNTED BOX 12 STOREY



Code : **9740249**

Model : **CMO-612**

Description

Flush-mounted box for entrance panel fixing. This box is made of metal. For ALOI series entrance panels. It has supports to hold and fold the entrance panel during installation, thus facilitating the work of connection and commissioning of the elements of the panel.

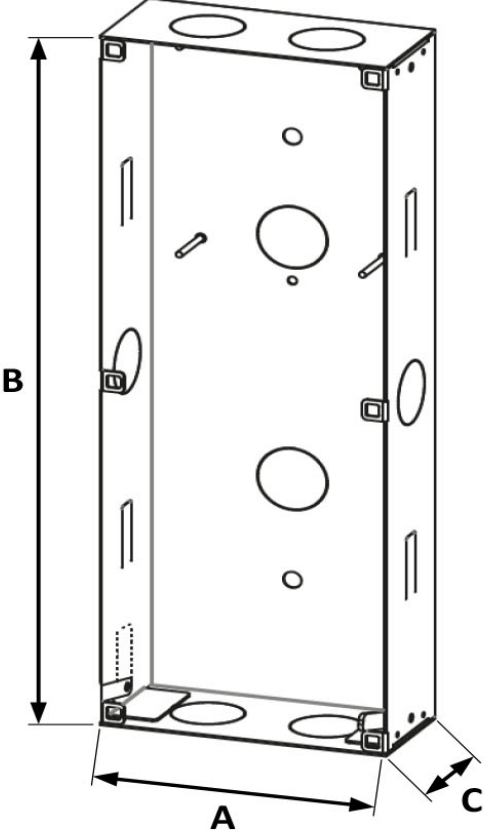
Code		9740249
Model		CMO-612
Dimensions	mm	<p>A:125 B:435 C:50</p>  <p>Illustration for reference only. It may not correspond to the product in every detail.</p>
Packing weight	Kg	1,03
Packing dimensions	mm	438 x 140 x 51