

DOOR ENTRY SYSTEMS

Video and audio intercom | Access control
Home automation

ALCAD
home

Enara 4.3" monitor

MVC-141 model



Colours as you had never seen before

Recording of images and videos

'Do not disturb' function

4.3-inch screen compatible with the Active View technology of our cameras



Micro SD card slot

Backlit capacitive buttons

The most compact hands-free monitor

Characteristics

- Improved image quality.
- Record of unanswered calls.
- Compatible with the Active View technology of our cameras.
- Languages: English, French, Italian, Portuguese, Turkish, Czech, Spanish, Catalan, Basque.
- Button for auxiliary functions.



Answer



Open



Aux





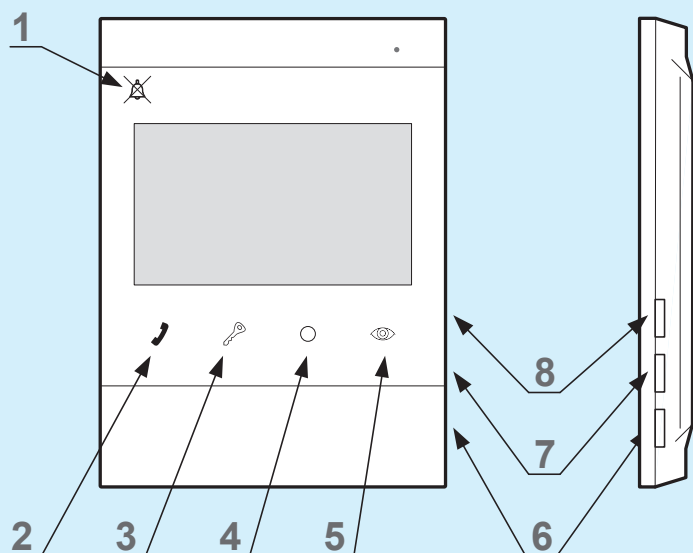



Look



MONITOR DESCRIPTION

Image display screen

-  **1. Call disabled indicator**
With the indicator on, the call volume 7 is at minimum and the call will not ring
-  **2. Communication button**
Touch button. It allows to establish communication when receiving the call and to cut the communication at the end of the call
-  **3. Door open button**
Touch button
-  **4. Button for auxiliary function**
Touch button. Allows you to perform additional functions (second door opening, lights on ...). Consult your installer
-  **5. Auto power button**
Touch button
- 6. Micro SD slot**
-  **7. Audio volume control**
Roulette-Button Control
-  **8. Screen adjustment button**
Hybrid Button: Push Button + Slider

ENARA 4.3-INCH MONITOR	
REFERENCE	9630087 MVC-141
System	2 wires
Screen	TFT Colour 4,3"
On-screen menu	Yes
Communication	Free hands
Call volume regulation	"Do not disturb"; 0-8
Buttons for auxiliary functions	1
Captures Photo / Video	Yes / Yes
Wi-Fi	No
Input Voltage	Through the 2-wires BUS (12,5 ... 18Vdc)
Consumption (mA)	40 mA (rest); 375 mA (active)
Work temperature	+5... +55 °C
Connections	Pluggable terminals
Integrated load and bypass	Yes, configurable by micro-switches
Installation	Surface mount
Proportions	120mm x 168mm x 26mm